

JWG16 – Formats for visualization and other derived forms of product data

Joint ISO/TC 184/SC 4 - ISO/IEC JTC 1/SC 24 - ISO/TC 171/SC 2 WG

<https://isotc.iso.org/livelink/livelink?func=ll&objId=19599172&objAction=browse&viewType=1>

2019-07-29

Soonhung Han, shhan@kaist.ac.kr

Christophe Mouton, christophe.mouton@edf.fr

Contents

- ◆ SC4 and JWG 16
- ◆ Projects
- ◆ Liaison
- ◆ JWG 16 members
- ◆ Long term projects
- ◆ Toulouse meeting May 2019

ISO TC184/SC4 organization

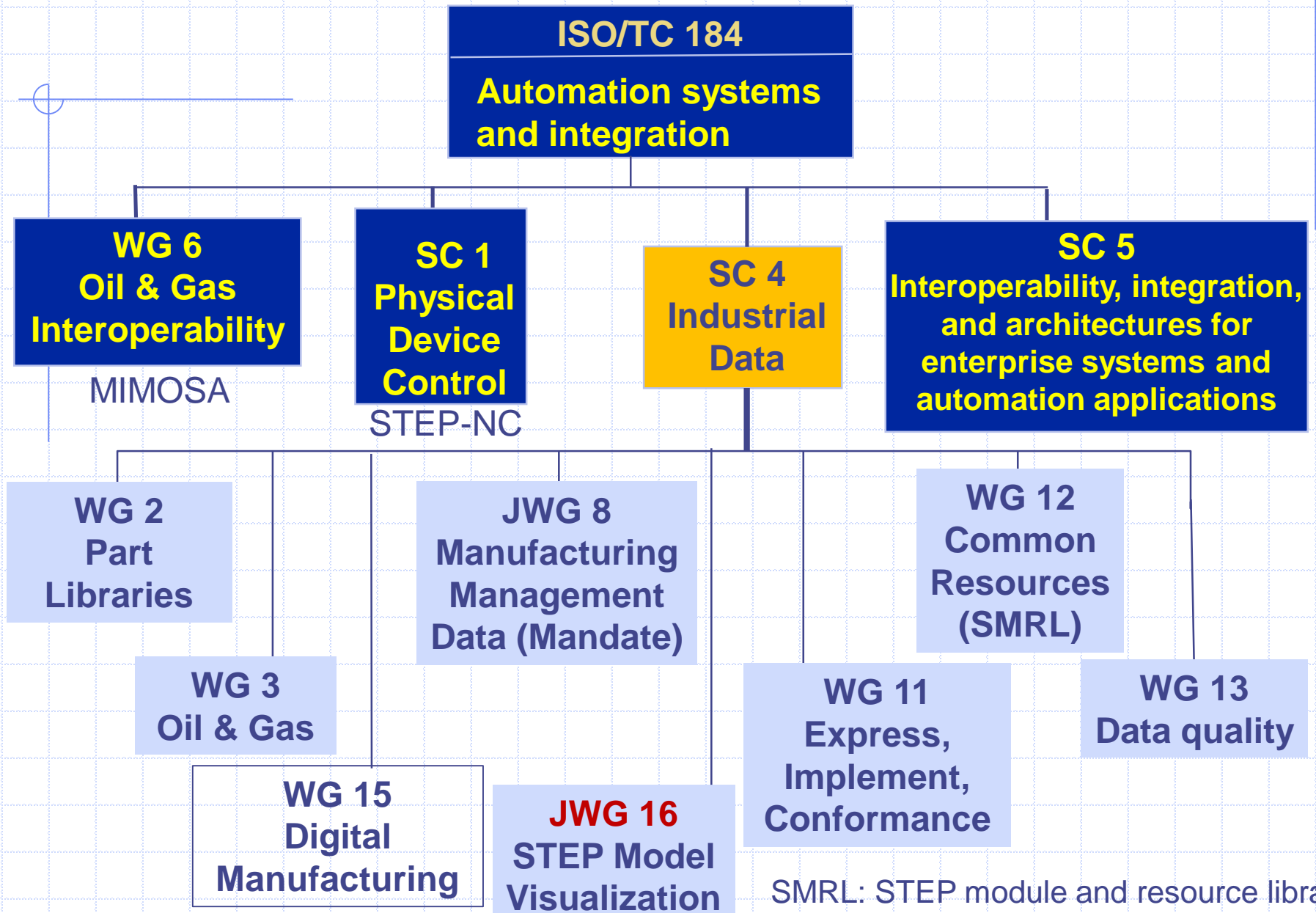

SC4 working groups

ISO/TC 184/SC 4 Industrial data

- ISO/TC 184/SC 4/PPC Policy and planning committee
- ISO/TC 184/SC 4/QC Quality committee
- ISO/TC 184/SC 4/AG 0 Change management advisory group
- ISO/TC 184/SC 4/WG 2 Product characteristics and libraries
- ISO/TC 184/SC 4/WG 3 Oil, Gas, Process and Power
- ISO/TC 184/SC 4/JWG 8 Joint SC4-SC5: Manufacturing process and management information
- ISO/TC 184/SC 4/WG 11 Implementation methods and conformance methods
- ISO/TC 184/SC 4/WG 12 STEP product modelling and resources
- ISO/TC 184/SC 4/WG 13 Industrial Data Quality
- ISO/TC 184/SC 4/WG 15 Digital Manufacturing
- ISO/TC 184/SC 4/WG 21 SMRL Validation Team
- ISO/TC 184/SC 4/WG 22 Reference data validation team
- ISO/TC 184/SC 4/WG 23 Vocabulary validation team

Evolution of Product Definition Capabilities

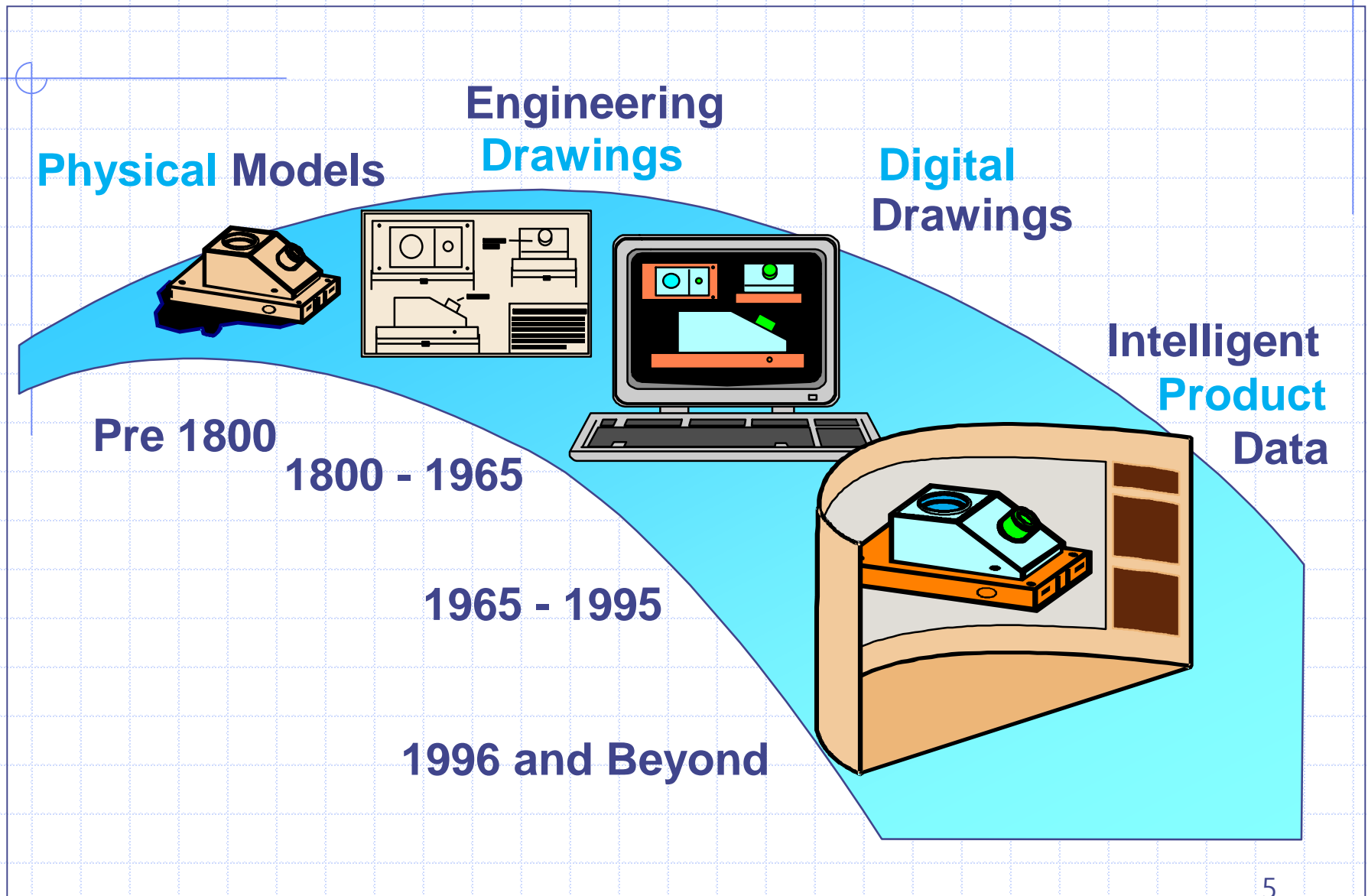

Drawing is for machining/manufacturing

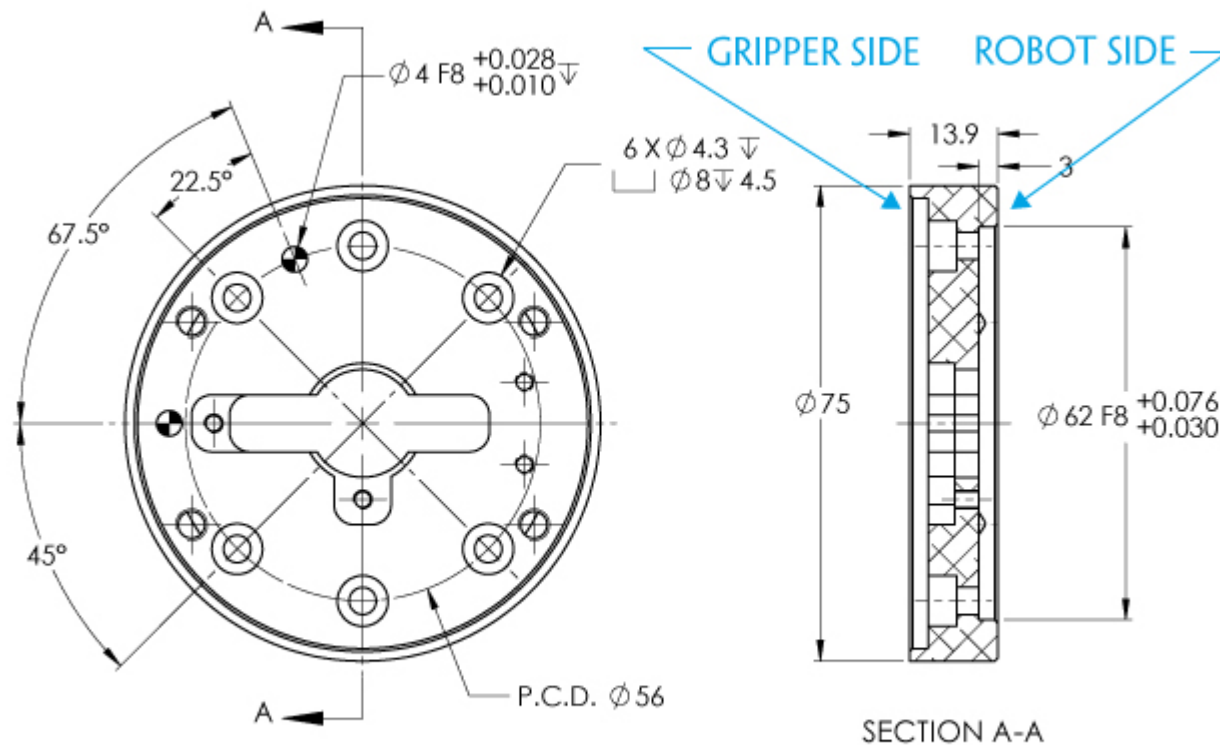

ISO TC184/SC4 standards

Short name	Number	Name	# books
STEP	ISO 10303	Product data representation and exchange Standard for the exchange of product model data	620
EXPRESS	ISO 10303-11	Information modeling language	3
PLIB	ISO 13584	Parts Library	14
MANDATE	ISO 15531	Industrial manufacturing management data	6
PSL	ISO 18629	Process specification language	9
IIDEAS	ISO 18876	integration of industrial data for exchange, access, and sharing	2
Process Plants	ISO15926	Integration of life-cycle data for process plants including oil and gas production facilities	7
OTD	ISO 22745	Open technical dictionaries and their application to master data	10
Data quality	ISO 8000	Data quality - Catalogue management systems -- Requirements	9

Projects of JWG16

- ◆ ISO/AWI 23301 **STEP geometry Services**, Brange
- ◆ Industrial **requirements** for product data visualisation: (Oscar Rocha, 2008), C. Mouton
- ◆ ISO 14306 ed3 **JT** file format specification for 3D visualization, John Humphreys (GE)
- ◆ Visualization elements of **digital twins**, S. Han
- ◆ Visualization components for the **PLM-MES interface** (for engineering plants), S. Han
- ◆ Convert ISO/PAS 17506 (**COLLADA**) to IS

Digital twins



Physical asset

Avatar

<https://igotoffer.com/blog/digital-twin/>

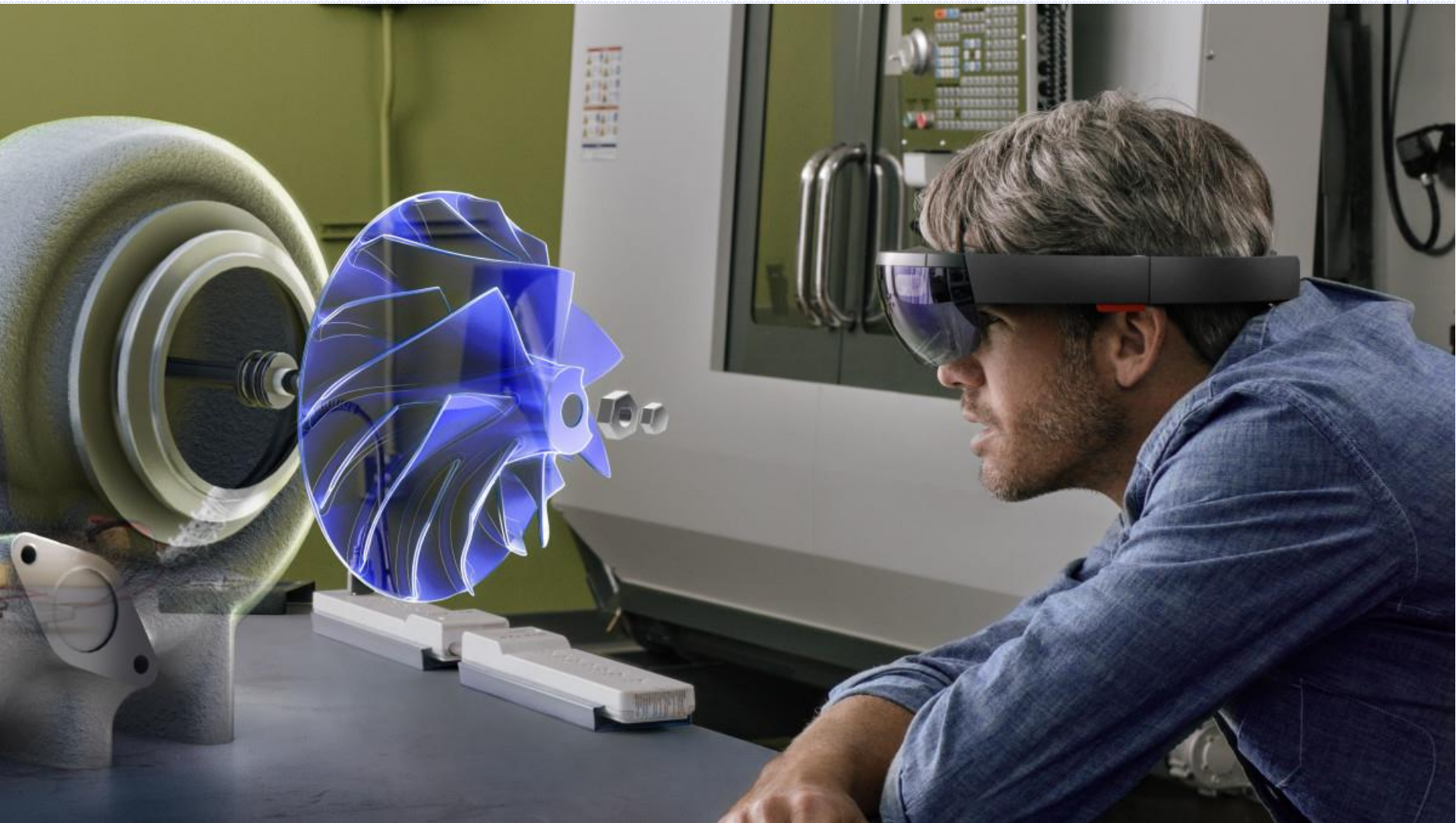

Reconstruction of plant Fidelity?



scanning



point cloud

CAD
model



4 Joint meetings @Toulouse

- ◆ 3DF PDF, ISO TC 171
- ◆ Web3D, JTC1/SC24
- ◆ WG3 - WG12/T1, Geometry Topology
Ontology
- ◆ TC59/JWG 12 - WG12/T1, BuildingSmart



ISO/TC 184/SC 4 /JWG 16

Summary:

- **Visualization** of product models including factories and plants

Scope:

- Consumption of product models with ISO/AWI 23301 STEP **Geometry Services**
- Joint WG with other 3D viz. standards:
 - ISO/IEC JTC1/SC24 (**X3D**)
 - ISO/ TC171/SC2 (**3D PDF**)
 - Format for 3D viz. of product models with ISO 14306 (**JT**)

Active work:

- NWI of STEP geometry Services
- Connection to smart manufacturing: **Digital twin** visualization

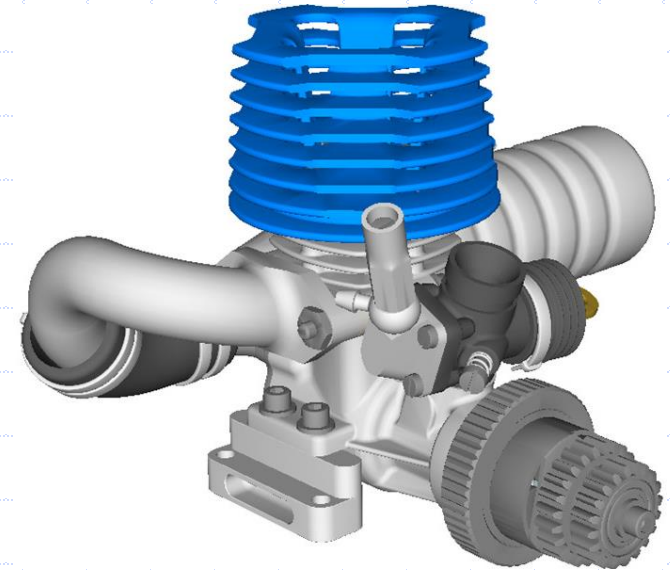
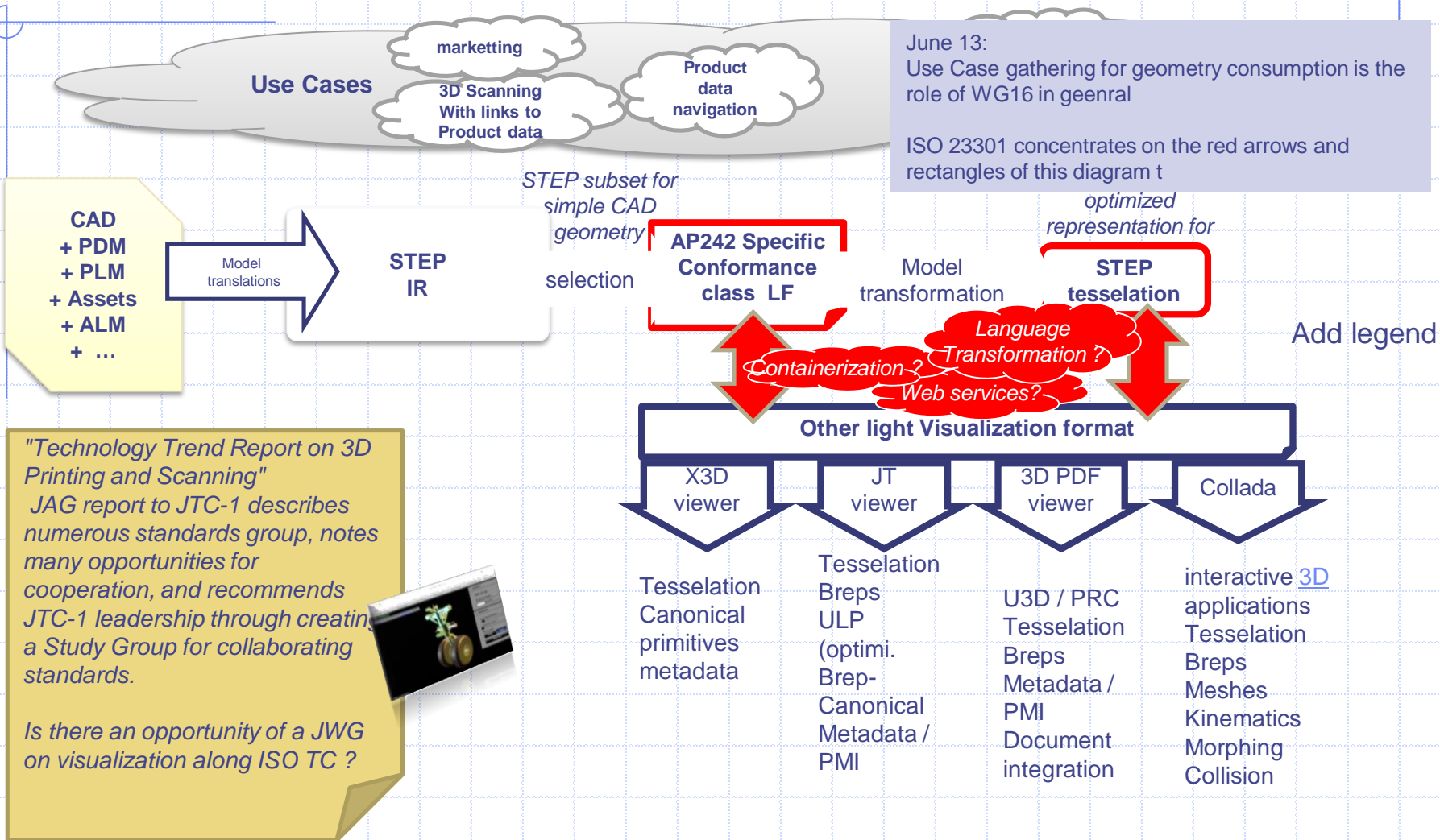

Image from Google

STEP Geometry Services ISO/AWI 23301



Visualisation requirements.

Status of Document

Reference:	Visualisation ad hoc group report Industrial requirements for product data visualisation.
Date:	2008-06-12.
Author:	Oscar ROCHA RENAULT SAS oscar.rocha@renault.com.
Type:	Report.
Doc-ID:	.
Revision:	3.0.
Status:	Final Version.

Liaison: Joint 3 TCs

- ◆ Initiated and hosted by ISO/TC 184/SC 4 industrial data
- ◆ Officially joint by:
 - ISO/IEC JTC 1/SC 24 - Computer graphics, image processing and environmental data representation
 - ◆ Co-convenor : Christophe MOUTON
 - ◆ WG 6 - Augmented reality continuum presentation and interchange
 - ISO/TC 171/SC 2 - Document file formats, EDMS systems and authenticity of information
 - ◆ WG 8 – PDF specification



web/3D

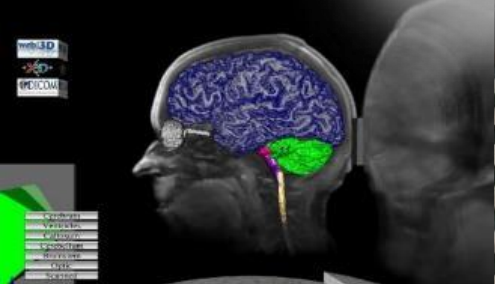

ISO/IEC JTC 1/SC 24 & Web3D consortium
in liaison report
75th ISO/TC 184/SC 4 plenary

TC 171 SC 2 WG 8

STEP Ad Hoc

Report, 3/6/18

1 The STEP Ad Hoc

During the December 2018 ISO/TC171/SC2 meetings in San Jose, WG8 resolved to form an Ad Hoc Group with TC184/SC4 to draft a proposal for including ISO 10303 (STEP) as a valid 3D stream. Members of the ad hoc are:

Name	Role
Phil Spreier	TC 171 SC 2 US TAG Chairperson / STEP Ad Hoc Chairperson
Leonard Rosenthol	TC 171 SC 2 Chairperson
Stuart Galt	TC 171 SC 2 SME
Peter Noyes	TC 171 SC 2 SME
Kenneth Swope	TC 184 SC 4 Chairperson
Soonhung Han	TC 184 SC 4 WG 16 Convener
Christophe Mouton	TC 184 SC 4 WG 16 Deputy Convener
Jean Brange	TC 184 SC 4 SME

2 STEP: ISO 10303

Viz. of big data

- ◆ **BIM**, IFC, ISO/TC 59/SC 13/JWG 12
- ◆ IOGP (international oil & gas producer)
 - www.iogp.org
- ◆ ISO 15926-3 Reference data for geometry and topology

JWG16 members

1	Convenor	ISO/TC 18	-	-	-	Han, Soonhung	shhan@kaist.ac.kr	-
2	Convenor	ISO/TC 18	-	-	M.	Mouton, Christophe	christophe.mouton@edf.fr	-
3	Committee	AFNOR	France	A - Industry and com	M.	Brangé, Jean	jean.brange@boost-conseil.com	-
4	Committee	AFNOR	France	A - Industry and com	M.	Caillet, Christian	c.caillet@datakit.com	-
5	Committee	AFNOR	France	A - Industry and com	M.	Chambolle, Frédéric	frederic.chambolle@mpsa.com	-
6	Committee	AFNOR	France	A - Industry and com	M.	DeLaunay, Jean-Yves	jean-yves.delahunay@airbus.com	-
7	Committee	AFNOR	France	A - Industry and com	M.	Duchier, Pierre	pierre.duchier@airbus.com	-
8	Committee	AFNOR	France	E - Academic and re	M.	Eynard, Benoît	benoit.eynard@utc.fr	-
9	Committee	AFNOR	France	A - Industry and com	M.	Heinisch, Jacques	jacques.heinisch@3ds.com	-
10	Committee	AFNOR	France	A - Industry and com	M.	Keraron, Yves	yves.keraron@isadeus.fr	-
11	Committee	AFNOR	France	E - Academic and re	M.	Lavoué, Guillaume	glavoue@liris.cnrs.fr	-
12	Committee	AFNOR	France	A - Industry and com	M.	Petit, Marc	marc-f.petit@edf.fr	-
13	Committee	ANSI	United States	B - Government	Ms.	Barnard Feeney, Allison	abf@nist.gov	-
14	Committee	ANSI	United States	B - Government	Mr	Bernstein, William	william.bernstein@nist.gov	-
15	Committee	ANSI	United States	A - Industry and com	Mr	Briggs, David	david.d.briggs@boeing.com	-
16	Committee	ANSI	United States	A - Industry and com	Mr	Ganguli, Jayendra	jayendra.s.ganguli@boeing.com	-
17	Committee	ANSI	United States	A - Industry and com	Mr	Humphreys, John	john.humphreys@qe.com	-
18	Committee	ANSI	United States	A - Industry and com	Ph.D	Li, Liming	Liming.Li@alumni.cgu.edu	-
19	Committee	ANSI	United States	B - Government	Mr	Lipman, Robert	robert.lipman@nist.gov	-
20	Committee	ANSI	United States	A - Industry and com	Mr	Rana, Rohan	Rohan.J.Rana@boeing.com	-
21	Committee	ANSI	United States	A - Industry and com	Mr	Sapp, Brandon	brandon.sapp@boeing.com	-
22	Committee	ANSI	United States	A - Industry and com	Ms	Schmidt, Diane	diane.schmidt@noeticpartners.com	-
23	Committee	ANSI	United States	A - Industry and com	Mr	Spreier, Phil	phil.spreier@3dpdfconsortium.org	-
24	Committee	ANSI	United States	A - Industry and com	Mr	Stevens, Jeffrey	jeff.a.stevens@gm.com	-
25	Committee	ANSI	United States	E - Academic and re	Dr	Urick, Benjamin	urickben@utexas.edu	-
26	Committee	ANSI	United States	A - Industry and com	-	Zink, Mike	mike.zink@siemens.com	+
27	Committee	DIN	Germany	A - Industry and com	Mr Dr.	Ungerer, Max	max.ungerer@prostep.com	+
28	Committee	JISC	Japan	E - Academic and re	Dr	Kobayashi, Kazuya	kobayasi@pu-toyama.ac.jp	-
29	Committee	JISC	Japan	A - Industry and com	Mr	Soma, Atsuto	soma@elysium.co.jp	-
30	Committee	KATS	Korea, Republic of	E - Academic and re	Mr	Choi, Young	yychoi@cau.ac.kr	-
31	Committee	KATS	Korea, Republic of	E - Academic and re	-	Han, Soonhung	shhan@kaist.ac.kr	-
32	Committee	KATS	Korea, Republic of	E - Academic and re	Mr	Kim, Hyunki	hk.kim@jbnu.ac.kr	-
33	Committee	KATS	Korea, Republic of	E - Academic and re	Mr	Kim, Youngki	kimyg5415@kaist.ac.kr	-
34	Committee	KATS	Korea, Republic of	E - Academic and re	Mr	Kwon, Soonjo	soonjoy@kaist.ac.kr	-
35	Committee	KATS	Korea, Republic of	E - Academic and re	-	Mun, Duhwan	dhmun@knu.ac.kr	-
36	Committee	KATS	Korea, Republic of	E - Academic and re	Dr	Suh, Suk hwan	shs@postech.ac.kr	+
37	Committee	KATS	Korea, Republic of	E - Academic and re	Mr	Yang, Jeongsam	iyang@ajou.ac.kr	-
38	Committee	KATS	Korea, Republic of	E - Academic and re	Mr	Yoon, Cheong-Hyuk	yoonyh@kaist.ac.kr	-
39	Committee	SAC	China	A - Industry and com	Mr	Duan, Haibo	hyman.duan@peraglobal.com	+
40	Committee	SAC	China	A - Industry and com	Mr	Wen, Jinlong	wenjinlong@wiz.top	-
41	Committee	SIS	Sweden	E - Academic and re	Mr	Lundgren, Magnus	brix@kth.se	-
42	Liaison ref	Web3D	-	A - Industry and com	Dr	Behr, Johannes	Johannes.behr@igd.fraunhofer.de	-
43	Liaison ref	Web3D	-	A - Industry and com	Mr	Marchetti, Vincent	vmarchetti@kshell.com	-
44	Liaison ref	ISO/TC 17	-	A - Industry and com	Mr.	Galt, Stuart	stuart.a.galt@boeing.com	-
45	Document	AFNOR	France	-	Mme	Jean, Mélissa	melissa.jean@afnor.org	-
46	Document	BSI	United Kingdom	-	Dr	Whitlock, Charles	charles.whitlock@bsigroup.com	+
47	Document	DIN	Germany	-	Mr	Gröpper, Meinolf	meinolf.groeppe@vdma.org	+
48	Document	JISC	Japan	-	Ms	Suzuki, Takako	e-iso@jsa.or.jp	-
49	Document	SIS	Sweden	-	Mr	Hussain, Hikmet	hikmet.hussain@sis.se	0
50	Technical	ISO	-	-	Mrs.	Mathew, Laura	mathe@iso.org	+
51								
52								
53	Liaison ref	ISO/IEC JT	-	A - Industry and com	Mr	Brutzman, Don	brutzman@nps.edu	+

JWG 16 Meeting Schedule (Rm Toulouse mostly)

This is the detailed meeting agenda for the 77th Meeting of TC 184/SC 4 Industrial Data held at Toulouse, France

	2019-05-12	2019-05-13	2019-05-14	2019-05-15	2019-05-16	2019-05-17
TIME	Sunday	Monday	Tuesday	Wednesday	Thursday	Friday
9:00 - 9:30		Opening Technical Session RM TBD	NWIP candidates	INDUSTRY DAY	Implementers Forum	Closing Technical Plenary: RM TBD
9:30 - 10:00		Opening Technical Session RM TBD	JT discussion	INDUSTRY DAY	Implementers Forum	Closing Technical Plenary: RM TBD
10:00 - 10:15	Break		Break	Break	Break	Break
10:15 - 11:00			JT discussion	INDUSTRY DAY	Draft resolutions due from Convenors	TC 184/SC 4 Busines Meeting: RM TBD
11:00 - 11:30			NWIP candidates	INDUSTRY DAY		TC 184/SC 4 Busines Meeting: RM TBD
11:30 - 12:00			viz of PLM-MES	INDUSTRY DAY		TC 184/SC 4 Busines Meeting: RM TBD
12:00 - 13:00	Lunch		Lunch	Lunch	Lunch	Close TC 184/SC 4 Meeting
13:00 - 13:30	PPC /Convenors Meeting RM TBD	JWG 16 planning of the week	SC 4 Change Board RM TBD	INDUSTRY DAY	TC59/JWG 12 - WG12/T1 - JWG 16	
13:30 - 14:00	PPC /Convenors Meeting RM TBD	JWG 16 - STEP Geometry Services	SC 4 Change Board RM TBD	INDUSTRY DAY	TC59/JWG 12 - WG12/T1 - JWG 16	
14:00 - 14:30	PPC /Convenors Meeting RM TBD	JWG 16 - Viz requirements	SC 4 Change Board RM TBD	INDUSTRY DAY	TC59/JWG 12 - WG12/T1 - JWG 16	
14:30 - 15:00	PPC /Convenors Meeting RM TBD	JWG 16 - Viz requirements	SC 4 Change Board RM TBD	INDUSTRY DAY	TC59/JWG 12 - WG12/T1 - JWG 16	
15:00 - 15:15	Break		Break	Break	Break	
15:15 - 15:30		JWG 16 - Collada	3DF PDF Liaison	INDUSTRY DAY	TC59/JWG 12 - WG12/T1 - JWG 16	
15:30 - 16:00		JWG 16 - Collada	Web3D Liaison	INDUSTRY DAY	TC59/JWG 12 - WG12/T1 - JWG 16	
16:00 - 16:30		JWG 16 - NWIP JT ed 3	SC 4 Change Board RM TBD	INDUSTRY DAY	TC59/JWG 12 - WG12/T1 - JWG 16	
16:30 - 17:00		JWG 16 - NWIP JT ed 3	SC 4 Change Board RM TBD	INDUSTRY DAY	TC59/JWG 12 - WG12/T1 - JWG 16	
17:00 - 17:30	Buffer		Buffer	Buffer	Buffer	
17:30 - 18:00		Open Technical Forum: RM TBD	WG3 - WG12/T1 - JWG 16	Social Event	NSB Caucuses	
18:00 - 19:00		Open Technical Forum: RM TBD	WG3 - WG12/T1 - JWG 16	Social Event	Coordinate with	
19:00 - 20:00				Social Event	Secretary for	

Toulouse
meeting
12-17 May
2019